

DAS UNIVERSELLE TÜRSYSTEM

VERSATILE DOOR



# HYDRA

COMPETENCE IN COMPONENTS

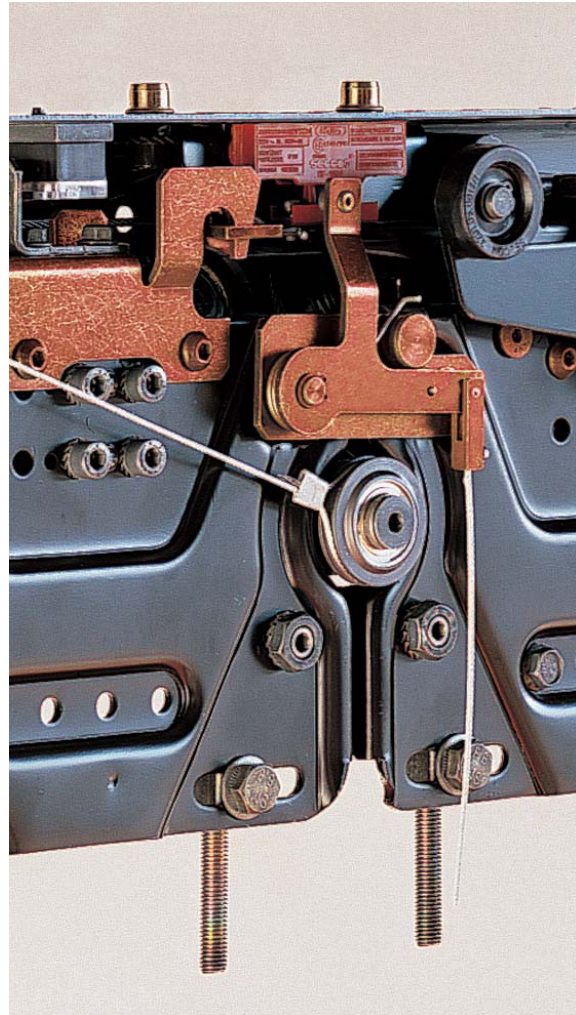

---

---

## TÜRSYSTEME DER ZUKUNFT *OPENING THE DOOR TO THE FUTURE*

### HYDRA - eindrucksvolle Vielseitigkeit

Dieses ausgereifte Standard-Türsystem veranschaulicht die Tradition unserer langjährigen Forschung und Entwicklung.

HYDRA wurde weltweit zu einem Synonym für die Vielfalt und den universellen Einsatz unserer automatischen Schiebetürsysteme.

Durch seine Vielseitigkeit eignet sich das Türsystem ideal für den gesamten Bereich der Aufzug-Modernisierung sowie für Neuanlagen mit mittlerem Verkehrsaufkommen.

Ob Varianten gemäß Katalog oder nach individuellen Kundenanforderungen, HYDRA bietet die größte Vielfalt. Das Türenprogramm steht in feuer- wasser- und staubgeschützter Ausführung zur Verfügung.

### HYDRA - impressive versatility

*The hydra type automatic door represents the continuation of Selcom's "tradition".*

*The wide variety of configurations and executions make the HYDRA door an ideal solution for every installation. Performance, reliability and versatility make it the "star" in the market.*

*Its versatility makes it ideal for the modernisation market and for balanced-traffic lifts.*

*Hydra offers a complete spectrum of finishes, ranging from all the options in our catalogue to specific customer requests. The versatility is renowned for its resistance to fire, water, environment and dust.*



Frequenz geregelter  
Riemenantrieb HYDRABELT: Die  
Weiterentwicklung der Tradition





















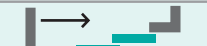
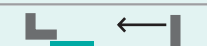

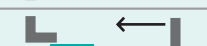
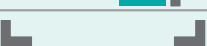
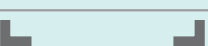
*Frequency controlled Hydrabelt  
operator: the development of  
tradition.*

DIE LÖSUNG FÜR JEDE ANFORDERUNG  
MANY EXECUTIONS TO ANSWER MANY DEMANDS

Produktionsbereich • production range

Fahrkorbabschlußtüren • Car doors

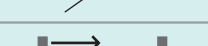
Serie 3201

HYDRARM							HYDRABELT						
SCHWELLE SILL DIMEN.	TYP TYPE	ILLUSTRATION	PL (mm)		LH (mm)		TYP TYPE	ILLUSTRATION	PL (mm)		LH (mm)		
			min.	max.	min.	max.			min.	max.	min.	max.	
75	02/C						02/C		600	1800			
90	12/R		500	1800	1900	Lichte Durchgangshöhe ist max. 3500 mm (wird stets in Abhängigkeit von der jeweiligen lichten Durchgangsbreite definiert) • Maximum clear opening high is 3500 mm. To be defined in function to door clear opening	12/R		600	1800	1900	Lichte Durchgangshöhe ist max. 3500 mm (wird stets in Abhängigkeit von der jeweiligen lichten Durchgangsbreite definiert) • Maximum clear opening high is 3500 mm. To be defined in function to door clear opening	
	12/L						12/L						
136	32/R			2100			32/R		600	2100			
	32/L						32/L						
90	33/R		600	1400			/	/	/	/			
	33/L						/	/	/	/			
	35/R						/	/	/	/			
	35/L						/	/	/	/			
	42/C						1200	3200	42/C				1200
	44/R		600	1150			44/R		600	1150			
136	62/C		1500	3200	62/C		1500	3200					
90	63/C		1200	2800	/	/	/	/					
136	66/R		900	1450 1700	/	/	/	/					
75	72/R		500	1400	72/R		600	1400					
	72/L				72/L								

 Auf Anfrage  
on request

DIE LÖSUNG FÜR JEDE ANFORDERUNG  
*MANY EXECUTIONS TO ANSWER MANY DEMANDS*

Der Fahrkorbtürmechanismus Mod. Hydra ist in zwei Ausführungen erhältlich:

- Arm-Ausführung (Mod. Hydrarm);
- Riemen-Ausführung (Mod. Hydrabelt).

Der Fahrkorbtürmechanismus Mod. Hydrarm ist mit folgender Motorisierung verfügbar:

- mit Wechselstrom-Motor (Standardausführung);
- mit Gleichstrom-Motor ohne Regler (auf Anfrage);
- mit Gleichstrom-Motor mit Regler RCRE24 oder RC48 (auf Anfrage).

Der Fahrkorbtürmechanismus Mod. Hydrabelt wird von einem durch den elektronischen Regler RCF1 frequenzgeregelten Wechselstrom-Motor angetrieben.

Alle Fahrkorbtürmechanismen mit Regler sind serienmäßig vorverdrahtet.

*The car door operator mod. Hydra is available in two versions:*

- *arm version (mod. Hydrarm);*
- *belt version (mod. Hydrabelt).*

*The car door operator mod. Hydrarm is supplied with the following motorizations:*

- *with A.C. motor (standard version);*
- *with D.C. motor without regulation (on request);*
- *with D.C. motor with regulator RCRE24 or RC48 (on request).*

*The car door operator mod. Hydrabelt is driven by an A.C. motor, frequency regulated by the electronic regulator RCF1.*

*The electric prewiring is a serial device for all operators with regulator.*

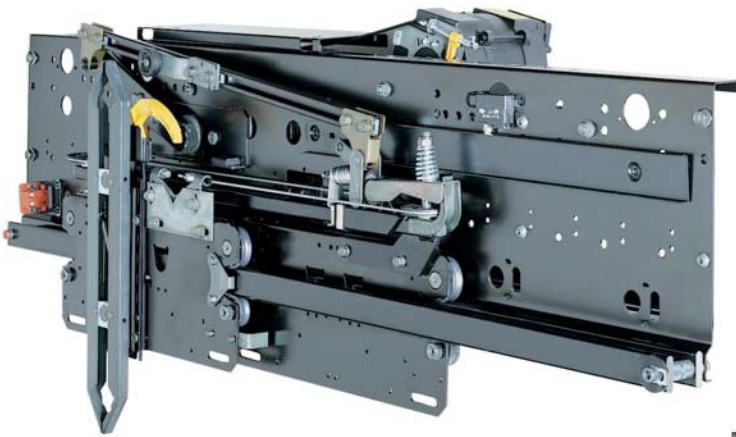

Fahrkorbtürmechanismus Mod. Hydrarm Typ 12/R mit Wechselstrom-Motor.







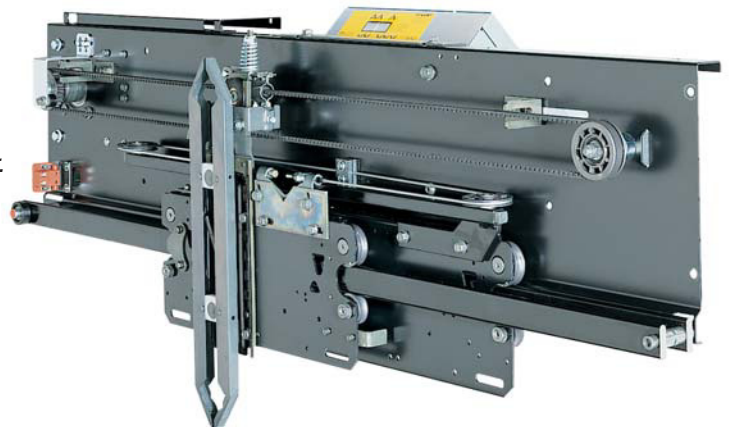



*Car door operator mod. Hydrarm type 12/R with A.C. motor.*

Fahrkorbtürmechanismus Mod. Hydrabelt Typ 12/R mit elektronischem Regler RCF1.

*Car door operator mod. Hydrabelt type 12/R with electronic regulator RCF1.*

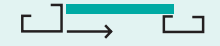

DIE LÖSUNG FÜR JEDE ANFORDERUNG  
MANY EXECUTIONS TO ANSWER MANY DEMANDS

Produktionsbereich • production range						
Schachttüren • landing doors						
SERIE 3201						
SCHWELLE SILL DIMEN.	TYP TYPE	ILLUSTRATION	PL (mm)		LH (mm)	
			min.	max.	min.	max.
75	01/C					
90	11/R		500	1800	1900	Lichte Durchgangshöhe ist max. 3500 mm (wird stets in Abhängigkeit von der jeweiligen lichten Durchgangsbreite definiert) Maximum clear high is 3500 mm. To be defined in function to door clear opening Lichte Durchgangshöhe nach EN 81 min. 2000 mm / Clear high acc. EN81 min. 2000 mm
	11/L					
136	31/R		600	2100		
	31/L					
90	/	/	/	/		
	41/C		1200	3200		
	43/R		600	1150		
136	61/C		1500	3200		
90	/	/	/	/		
136	65/R		900	1450 1700		
75	71/R		500	1400		
	71/L					

 Auf Anfrage  
on request

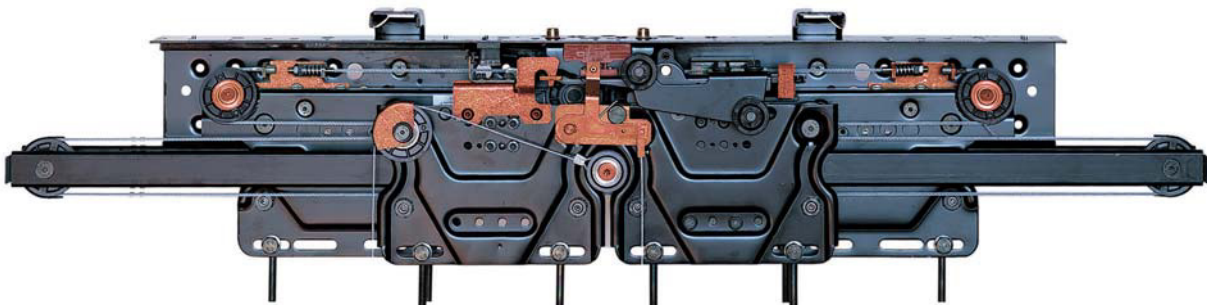

Schachtmechanismus Mod. HYDRA TYP 43/R.  
Landing mechanism mod. Hydra type 43/R.



**Produktionsunternehmen**  
*Manufacturing companies*

**Argentina: SOIMET SAICI**  
Av. Belgrano 2445,  
(B1872FVD) Sarandi - Pcia. de Buenos Aires  
Argentina  
Phone +54 11 4 205-1420, Fax +54 11 4 205-4745  
<http://www.soimet.com>, [info@soimet.com](mailto:info@soimet.com)

**Australia: WITTUR PTY. LTD.**  
9 Squill Place, Arndell Park, NSW 2148, Australia  
Phone + 61 2 9676 3711, Fax + 61 2 9676 3722  
[info@wittur.com.au](mailto:info@wittur.com.au)

**Austria: WITTUR GMBH**  
Sowitschstrasse 1, A-3270 Scheibbs  
Phone +43 7482 42542 0, Fax +43 7482 42542 32  
[info@wittur.at](mailto:info@wittur.at)

**Austria: WITTUR GMBH**  
Voitgasse 6, A-1220 Wien  
Phone +43 1 258 55 00 0, Fax +43 1 258 55 00 109  
<http://www.wittur.at>, [info@wittur.at](mailto:info@wittur.at)

**Brasil: WITTUR LTDA.**  
Rodovia Celso Garcia Cid, 1406  
Jardim Ana Elisa - 86188-000 Cambe - PR  
Brasil  
Phone: +55 43 251 21 00, Fax +55 43 251 21 30  
[info.pr@wittur.com.br](mailto:info.pr@wittur.com.br)

**Canada: WITTUR INC.**  
9437 192nd Street, V4N 3R7 Surrey (BC) Canada  
Phone: +1 604 881 2577, Fax: +1 604 881 2574  
<http://wittur.com>, [info-na@wittur.com](mailto:info-na@wittur.com)

**China: WITTUR ELEVATOR COMPONENTS (SUZHOU) CO., LTD.**  
No. 18 Shexing Road, Beishe Township, Wujiang, Jiangsu Province, China 215214  
Phone +86 512 632 20 888, Fax +86 512 632 20 044  
<http://www.wittur.com.cn>, [info@wittur.com.cn](mailto:info@wittur.com.cn)

**Germany: SYSTEM ANTRIEBSTECHNIK DRESDEN GMBH**  
Offenburger Str. 3, D-01189 Dresden  
Phone +49 351 40 440, Fax +49 351 40 44 111  
<http://www.sadgmbh.de>, [info@sadgmbh.de](mailto:info@sadgmbh.de)

**Germany: WITTUR GMBH**  
Frankfurter Straße 22, D-65527 Niedernhausen  
Phone: +49 6127 9061 0, Fax: +49 6127 9061 90  
[info@witturgmbh.de](mailto:info@witturgmbh.de)

**Italy: WITTUR S.P.A., COLORNO OFFICE**  
Via Macedonio Melloni, 12, I-43052 Colorno (PR)  
Phone +39 0521 311 1, Fax +39 0521 311 200  
<http://www.wittur.it>, [info@wittur.it](mailto:info@wittur.it)

**Italy: WITTUR S.P.A., ALBERI OFFICE**  
Via Martinella, 42/b, I-43010 Alberi (PR)  
Phone +39 0521 969938, Fax +39 0521 967974  
[info@spotticabine.it](mailto:info@spotticabine.it)

**Italy: SICOR S.P.A.**  
Via Nanni Costa, 14, I-40133 Bologna  
Phone +39 051 6421611, Fax +39 051 6421600

**Italy: SICOR S.P.A.**  
Viale Caproni, 15, I-38068 Rovereto (TN)  
Phone +39 0464 484 111, Fax +39 0464 484 100  
<http://www.sicor-spa.it>, [info@sicor-spa.it](mailto:info@sicor-spa.it)

**Italy: OMAR LIFT S.R.L.**  
Via F.lli Kennedy, 22/D, I-24060 Bagnatica (BG)  
Phone +39 035 689611, Fax +39 035 689671  
<http://www.omarlift.it>, [info@omarlift.it](mailto:info@omarlift.it)

**Spain: SELCOM ARAGÓN, S.A.**  
Poligono Industrial Las Acacias, C/Ebro, 26,  
E-28840 Mejorada del Campo (Madrid)  
Phone +34 91 6794340, Fax +34 91 6790139  
[info@selcom-aragon.com](mailto:info@selcom-aragon.com)

**Spain: SELCOM ARAGÓN, S.A.**  
Poligono Ind. Malpica, Calle E - n° 8  
E-50016 Zaragoza  
Phone +34 976 763900, Fax +34 976 763901  
<http://www.selcom-aragon.com>,  
[info@selcom-aragon.com](mailto:info@selcom-aragon.com)

**Turkey: WITTUR ASANSÖR SANAYI VE TICARET LTD. SİRKETİ**  
Dudullu Organize Sanayi Bölgesi No:13  
Ümraniye TR 34776 İstanbul Türkiye  
Phone +90 216 415 55 67, Fax +90 216 415 55 68  
<http://www.wittur.com.tr>, [info@wittur.com.tr](mailto:info@wittur.com.tr)

**United Kingdom: LIFTEKNIC LIMITED**  
PO Box 987, 7702 Fifth Avenue, Strother Field Industrial  
Park, Arkansas City, Kansas 67005 USA  
Phone +44 (0) 1352 707470, Fax +44 (0) 1352 707471  
<http://www.lifteknik.co.uk>, [info@lifteknik.co.uk](mailto:info@lifteknik.co.uk)

**USA: WITTUR INC.**  
PO Box 987, 7702 Fifth Avenue, Strother Field Industrial  
Park, Arkansas City, Kansas 67005 USA  
Phone +1 620 442 2510, Fax +1 620 442 7041  
[info@selcom-usa.com](mailto:info@selcom-usa.com)

**Logistik**  
*Logistic*

**Belgium: WITTUR NV/SA**  
Industriezone Mechelen Zuid II  
E. Walschaertsstraat 15/15, B-2800 Mechelen  
Phone: +32 15 28 40 90, Fax: +32 15 42 1207  
[info@wittur.be](mailto:info@wittur.be)

**Brasil: WITTUR LTDA.**  
Avda. Santa Catarina, 788  
Vila Santa Catarina - 04378-000 Sao Paulo - SP  
Brasil  
Phone: +55 11 5032-0818, Fax +55 11 5032-1622  
[info@wittur.com.br](mailto:info@wittur.com.br)

**Canada: WITTUR INC., TORONTO OFFICE**  
Unit 11 - 4055 Sladeview Crescent, Mississauga ON,  
Canada L5L 5Y1  
Phone +1 905 820 1594 Fax +1 905 820 16 01  
Toll free 1-800-417-2892  
<http://wittur.com>, [info-na@wittur.com](mailto:info-na@wittur.com)

**China: WITTUR ELEVATOR COMPONENTS (SUZHOU) CO. LTD. BEIJING OFFICE**  
Room 311 Zhouji Edifice, No.16 Ande Road,  
Dongcheng District,  
Beijing, China 100011  
Phone +86 10 84882413; Fax +86 10 84882412  
<http://www.wittur.com.cn>, [bjoffice@wittur.com.cn](mailto:bjoffice@wittur.com.cn)

**China: WITTUR ELEVATOR COMPONENTS SUZHOU CO. LTD., GUANGZHOU OFFICE**  
Room 2306, Bank of America Plaza,  
No. 555 Ren Min Road, Guangzhou 510145, China  
Phone +86 20 8130 3517, Fax +86 20 8130 3052  
<http://www.wittur.com.cn>, [gzoffice@wittur.com.cn](mailto:gzoffice@wittur.com.cn)

**China: WITTUR ELEVATOR COMPONENTS (SUZHOU) CO. LTD. SHANGHAI OFFICE**  
6F/C Lugang Huangpu Center, No. 98 Liuhe Road,  
Shanghai, 200001, China  
Phone +86 21 6360 3933/ 6360 3935  
Fax +86 21 6360 3932  
<http://www.wittur.com.cn>, [shoffice@wittur.com.cn](mailto:shoffice@wittur.com.cn)

**Croatia: WITTUR D.O.O.**  
Horvatova 27, Sv. Klara  
HR-10020 Zagreb  
Phone / Fax +385 1 6606777, Phone +385 1 6606778  
[wittur@zg.hinet.hr](mailto:wittur@zg.hinet.hr)

**Czech Republic: WITTUR S.R.O.**  
Javorová 1, CZ-693 01 Hustopeče u. Brna  
Phone +420 519413415, Fax +420 519413416  
[info@wittur.cz](mailto:info@wittur.cz)

**France: WITTUR S.A.R.L.**  
7, Rue des Cévennes-CE 1815,  
ZI de la Petite Montagne Sud, F-91018 Evry Cedex  
Phone +33 1 60 86 06 04, Fax +33 1 60 86 20 46  
[courrier@wittur.fr](mailto:courrier@wittur.fr)

**Germany: WITTUR AG**  
Rohrbachstr. 26-30, D-85259 Wiedenzhausen  
Phone +49 8134 18 0, Fax +49 8134 18 49  
<http://www.wittur.com>, [info@wittur.com](mailto:info@wittur.com)

**Hong Kong: WITTUR LTD.**  
Unit 1901-02, 19/F, 682-684 Castle Peak Road,  
Kowloon, Hong Kong  
Phone +852 2462 6222, Fax +852 2460 7946  
[info@wittur.com.hk](mailto:info@wittur.com.hk)

**Hungary: WITTUR KFT.**  
Róbert Károlyi krt. 61-65., I. em., H-1134 Budapest  
Phone +36 1 465 6907, Fax +36 1 465 6915  
[info@wittur.hu](mailto:info@wittur.hu)

**Italy: WITTUR ROMA S.R.L.**  
Via della Magliana 56, I-00146 Roma  
Phone +39 06 55 77 361, Fax +39 06 55 79 725  
[info@wittur-roma.it](mailto:info@wittur-roma.it)

**Israel: WITTUR LTD.**  
7 Yad-Harutzim Street, P.O.B. 8319  
New industrial zone, Natanya 42505, Israel  
Phone +972 9 8350405, Fax +972 9 8350598  
[info@wittur.co.il](mailto:info@wittur.co.il)

**Japan: WITTUR K.K.**  
4F, Hayama Building 5, 1-3-1 Zip 222-0033,  
Shin Yokohama, Kohoku-ku, Yokohama, Japan  
Phone +81 45 478 1791, Fax +81 45 478 1792  
[info@wittur.co.jp](mailto:info@wittur.co.jp)

**Netherlands: WITTUR B.V.**  
Industrieterrein "De Vaart", Remmingweg 18,  
Postbus 1002, NL-1300 BA Almere  
Phone +31 36 532 07 00, Fax +31 36 532 23 68  
<http://www.wittur.nl>, [info@wittur.nl](mailto:info@wittur.nl)

**Poland: WITTUR SP. Z O.O.**  
ul. Rzymowskiego 30 lokal 207, 02-697 Warszawa  
Phone: +48 22 853 89 50, Fax +48 22 853 89 51  
<http://www.wittur.pl>, [info@wittur.pl](mailto:info@wittur.pl)

**Portugal: WITTUR LDA. COMPONENTES PARA ELEVADORES**  
Zona ind. Cabra Figa, lote 2, Estrada Nacional 249 - 4  
PT-2635 - 047 Rio de Mouro  
Phone +351 21915 85 20, Fax +351 21915 85 29  
[witturlda@net.sapo.pt](mailto:witturlda@net.sapo.pt)

**Singapore: WITTUR PTE., LTD.**  
16 Tuas Avenue 11 Singapore 639082  
Phone +65 6898 4962, Fax +65 6898 4961  
[info@wittur.com.sg](mailto:info@wittur.com.sg)

**Spain: WITTUR SPAIN, S.L.**  
Poligono Ind. Malpica, Calle E - n° 8  
E-50016 Zaragoza  
Phone +34 976 763 900, Fax +34 976 763 901  
<http://www.wittur.es>, [info@wittur.es](mailto:info@wittur.es)

**Spain: WITTUR SPAIN, S.L., BARCELONA OFFICE**  
Poligono Ind. Almeda, Calle Mercuri, 38-40  
08940 Cornellá de Llobregat (Barcelona)  
Phone +34 93 474 3330, Fax +34 93 474 3464  
[sales-barcelona@wittur.es](mailto:sales-barcelona@wittur.es)

**Spain: WITTUR SPAIN, S.L., MADRID OFFICE**  
Poligono Ind. Las Acacias, Calle Ebro, 26  
28840 Mejorada del Campo (Madrid)  
Phone +34 91 679 4340, Fax +34 91 679 0139  
[sales-madrid@wittur.es](mailto:sales-madrid@wittur.es)

**Sweden: WITTUR AB**  
Ekbacksvägen 28, 168 69 Bromma  
Phone +46 8555 36 305, Fax +46 8555 36 306  
[info@wittur.se](mailto:info@wittur.se)

**Switzerland: WITTUR AG**  
Mitteldorfstrasse 37a, CH-6315 Oberägeri  
Phone +41 41 754 57 57, Fax +41 41 754 57 58  
<http://www.wittur.ch>, [info@wittur.ch](mailto:info@wittur.ch)

**Vertretungen**  
*Agents*

**OMAR**

**Greece: OMAR LIFT agent**  
ANELCO A.E.  
Paparigopoulo St. 50, GR-12132 Peristeri,  
Athens  
Phone +30 1 5751654, Fax +30 1 5752861

**SICOR**

**Iran: SICOR agent**  
ALIREZA RAHIMI ARDELI c/o Kouple Ascensor Co.  
4th Floor No. 19, Bagher Khan Street,  
14196 Tehran, Iran  
Phone +98 21 6420964, Fax +98 21 6420965  
[kouple@systemgroup.net](mailto:kouple@systemgroup.net)

**WITTUR (SELCOM doors)**

**Greece: WITTUR agent**  
KOSTAS KARABELAS S.A.  
109 Alkamenous Street, GR-10446 Athens  
Phone: +30 210 8811927, Fax +30 210 8822308  
[kara-sa@ath.forthnet.gr](mailto:kara-sa@ath.forthnet.gr)

**Egypt: WITTUR agent**  
(Production under *WITTUR* licence)  
ELTOUNY ELEVATOR CO.  
3rd Industrial Area - Plot No. 122 -  
6th of October City, Egypt  
Phone +2 011 34 34 40 / 34 34 50, Fax +2 011 340 140  
<http://www.eltony.com>, [eltony@eltony.com](mailto:eltony@eltony.com)

**WITTUR (all products)**

**Norway: WITTUR agent**  
HAANES IMPORT AS  
Postboks 199 Sentrum, N-0102 Oslo,  
Phone +47 22 412965, Fax +47 22 426719

**India: WITTUR agent**  
M.S. Mangaleswaran  
B - 3, Shanti Empress, 72, L.B. Road, Thiruvannamur  
Chennai - 600 041  
Phone +91(0) 44 2 4929150, Fax +91(0) 44 2 4482153  
[witturindia@eth.net](mailto:witturindia@eth.net)

**Korea: WITTUR agent**  
SDC Korea  
#503, 256-13 Gongduck-dong, Mapo-ku,  
Seoul, Korea  
Phone +82 2 3211 2536, Fax +82 2 3272 2535  
[sh.kim@wittur.com](mailto:sh.kim@wittur.com)

**Zentrale / Head Office**

**WITTUR AG**

Rohrbachstr. 26-30, D-85259 Wiedenzhausen  
Phone +49 8134 18 0, Fax +49 8134 18 49  
<http://www.wittur.com>, [info@wittur.com](mailto:info@wittur.com)

**Ihr Ansprechpartner**

*Please contact*